



## Screw-type heat meter G20/G21

Screw-type heat meter with optical interface for retrofitting to external modules. Thanks to integrated modules, the devices can be equipped with the required communication technology ex factory.

For use in the Q opto and Q basic systems or through an integrated communication module in the Q M-Bus system.

Can be retrofitted with external modules for use in the systems Q M-Bus, Q walk-by and Q AMR.

As series G21 with combined heat and cold metering.

## Application

The heat meter is used for measuring heat energy. With model G21, the combined measurement of heat and cold energy is possible. The main areas of application are in central heating systems where the heating energy is outputted individually to different consumers.

This is meaningful in:

- ~ Apartment buildings
- ~ Offices and administration buildings

Typical users are:

- ~ Metering service companies
- ~ Housing associations
- ~ Property management companies
- ~ Specialist companies for sanitary, heating and air-conditioning technology

## Functions

- ~ Heat meter G20 or combined heat/cold meter G21 for direct or indirect installation of the temperature sensors
- ~ Optical interface for external communication modules
- ~ Internal communication modules for M-Bus and impulse available ex factory
- ~ Mains-independent, for local use, 6 or 10-year lithium battery
- ~ PTB-approved, approval no. D 22.12/04.03
- ~ MID-approved, type approval certificate PTB DE-08-MI004-PTB013
- ~ Values are measured by two platinum PT 1000 resistance thermometers and one hydraulic impeller wheel sensor with patented magnet-free scanning according to the conductance principle with carbide-sapphire bearings for low-wear and reliable long-term measuring operation
- ~ High resolution thanks to 7-digit LC display that indicates current value, old value, check number and many service and operating parameters
- ~ Additional display of 18 monthly values with date
- ~ Storage of the maximum supply flow and return flow temperatures as well as the maximum current flow with date
- ~ Programming of a due date can be carried out on-site via the optical interface
- ~ Add-on modules for radio or M-Bus communication as well as impulse output and RS 232 modules can be retrofitted at any time on-site via the optical interface
- ~ Thanks to integrated modules, the devices can be equipped with the required communication technology (M-Bus or impulse output) ex factory

**Type summary**

Part number

G20 / G21

Heat meter

Heat/cold meter

**0.6 m<sup>3</sup>/h for immersion sleeve and direct measurement - temperature sensor 5.0 x 45 mm**

with 1.5 m temperature sensor cable G ¾ x 110 mm	G20/0000-00	G21/0000-00
with 3.0 m temperature sensor cable G ¾ x 110 mm	G20/0300-00	G21/0300-00

**1.5 m<sup>3</sup>/h for immersion sleeve and direct measurement - temperature sensor 5.0 x 45 mm**

with 1.5 m temperature sensor cable G ¾ x 110 mm	G20/0010-00	G21/0010-00
with 3.0 m temperature sensor cable G ¾ x 110 mm	G20/0310-00	G21/0310-00

**2.5 m<sup>3</sup>/h for immersion sleeve and direct measurement - temperature sensor 5.0 x 45 mm**

with 1.5 m temperature sensor cable G 1 x 130 mm	G20/0020-00	G21/0020-00
with 3.0 m temperature sensor cable G 1 x 130 mm	G20/0320-00	G21/0320-00

**0.6 m<sup>3</sup>/h for direct measurement - temperature sensor acc. to AGFW**

with 1.5 m temperature sensor cable G ¾ x 110 mm	G20/8000-00	G21/8000-00
with 3.0 m temperature sensor cable G ¾ x 110 mm	G20/8300-00	G21/8300-00

**1.5 m<sup>3</sup>/h for direct measurement - temperature sensor acc. to AGFW**

with 1.5 m temperature sensor cable G ¾ x 110 mm	G20/8010-00	G21/8010-00
with 3.0 m temperature sensor cable G ¾ x 110 mm	G20/8310-00	G21/8310-00

**2.5 m<sup>3</sup>/h for direct measurement - temperature sensor acc. to AGFW**

with 1.5 m temperature sensor cable G 1 x 130 mm	G20/8020-00	G21/8020-00
with 3.0 m temperature sensor cable G 1 x 130 mm	G20/8320-00	G21/8320-00

## G20 / G21 for external installation spots

**0.6 m<sup>3</sup>/h for immersion sleeve measuring - temperature sensor 5.2 x 45 mm**

with 1.5 m temperature sensor cable G ¾ x 110 mm	G20/1000-00	G21/1000-00
with 3.0 m temperature sensor cable G ¾ x 110 mm	G20/1300-00	G21/1300-00

**1.5 m<sup>3</sup>/h for immersion sleeve measuring - temperature sensor 5.2 x 45 mm**

with 1.5 m temperature sensor cable G ¾ x 110 mm	G20/1010-00	G21/1010-00
with 3.0 m temperature sensor cable G ¾ x 110 mm	G20/1310-00	G21/1310-00

**2.5 m<sup>3</sup>/h for immersion sleeve measuring - temperature sensor 5.2 x 45 mm**

with 1.5 m temperature sensor cable G 1 x 130 mm	G20/1020-00	G21/1020-00
with 3.0 m temperature sensor cable G 1 x 130 mm	G20/1320-00	G21/1320-00

**0.6 m<sup>3</sup>/h for immersion sleeve measuring - temperature sensor 6.0 x 50 mm**

with 1.5 m temperature sensor cable G ¾ x 110 mm	G20/2000-00	G21/2000-00
with 3.0 m temperature sensor cable G ¾ x 110 mm	G20/2300-00	G21/2300-00

**1.5 m<sup>3</sup>/h for immersion sleeve measuring - temperature sensor 6.0 x 50 mm**

with 1.5 m temperature sensor cable G ¾ x 110 mm	G20/2010-00	G21/2010-00
with 3.0 m temperature sensor cable G ¾ x 110 mm	G20/2310-00	G21/2310-00

**2.5 m<sup>3</sup>/h for immersion sleeve measuring - temperature sensor 6.0 x 50 mm**

with 1.5 m temperature sensor cable G 1 x 130 mm	G20/2020-00	G21/2020-00
with 3.0 m temperature sensor cable G 1 x 130 mm	G20/2320-00	G21/2320-00

## Type summary

G20 / G21 with internal module	Part number *	
	Heat meter	Heat/cold meter

### Internal communication modules

M-BUS module	G20/xxx2-xxx	G21/xxx2-xx
Impulse output	G20/xxx3-xxx	G21/xxx3-xx

\* x = any option code

## Further order options

### Volume measurement in heat pipes

Immersion sleeve and direct measurement, temperature sensor 5.0 x 45 mm	G20/Axxx-xxx	G21/Axxx-xx
Immersion sleeve measurement, temperature sensor 5.2 x 45 mm	G20/Bxxx-xxx	G21/Bxxx-xx
Immersion sleeve measurement, temperature sensor 6.0 x 50 mm	G20/Cxxx-xxx	G21/Cxxx-xx
Direct measurement, temperature sensor acc. to AGFW	G20/Kxxx-xxx	G21/Kxxx-xx

\* x = any option code

## Further accessories

Order data	Part no.
Programming key for due date programming	G99/PAFF-01
Remote display with wall bracket,	R99/FANZ-01 390 980
inc. plug-in cable 2.5 m long Extension cable 5 m long	
M-Bus cable with sealable plug,	593 812
Impulse cable with sealable plug,	593 812
	593 559

\* only for devices with integrated modules

## Installation material

### Direct temperature measurement

Order data	Part no.
Direct measurement installation set R 1/2" with RL screwed connections for WMZ with $q_p$ 0.6 m <sup>3</sup> /h and 1.5 m <sup>3</sup> /h	592 977
Direct measurement installation set R 3/4" with RL screwed connections for WMZ with $q_p$ 0.6 m <sup>3</sup> /h and 1.5 m <sup>3</sup> /h	592 978
Direct measurement installation set R 1" with RL screwed connections for WMZ with $q_p$ 0.6 m <sup>3</sup> /h and 1.5 m <sup>3</sup> /h	592 979
Direct measurement installation set R 3/4" with RL screwed connections for WMZ with $q_p$ 2.5 m <sup>3</sup> /h	592 980
Direct measurement installation set R 1" with RL screwed connections for WMZ with $q_p$ 2.5 m <sup>3</sup> /h	592 981
Direct measurement installation set R 1/2" with RL ball valves for WMZ with $q_p$ 0.6 m <sup>3</sup> /h and 1.5 m <sup>3</sup> /h	592 982
Direct measurement installation set R 3/4" with RL ball valves for WMZ with $q_p$ 0.6 m <sup>3</sup> /h and 1.5 m <sup>3</sup> /h	593 983
Direct measurement installation set R 1" with RL ball valves for WMZ with $q_p$ 0.6 m <sup>3</sup> /h and 1.5 m <sup>3</sup> /h	592 984
Direct measurement installation set R 3/4" with RL ball valves for WMZ with $q_p$ 2.5 m <sup>3</sup> /h	592 985
Direct measurement installation set R 1" with RL ball valves for WMZ with $q_p$ 2.5 m <sup>3</sup> /h	592 986

### Indirect temperature measurement

Order data	Part no.
Immersion sleeve installation set R 1/2" with RL screwed connections for WMZ with $q_p$ 0.6 m <sup>3</sup> /h and 1.5 m <sup>3</sup> /h	531 236
Immersion sleeve installation set R 3/4" with RL screwed connections for WMZ with $q_p$ 0.6 m <sup>3</sup> /h and 1.5 m <sup>3</sup> /h	531 237
Immersion sleeve installation set R 1" with RL screwed connections for WMZ with $q_p$ 0.6 m <sup>3</sup> /h and 1.5 m <sup>3</sup> /h	531 238
Immersion sleeve installation set R 3/4" with RL screwed connections for WMZ with $q_p$ 2.5 m <sup>3</sup> /h	531 713
Immersion sleeve installation set R 1" with RL screwed connections for WMZ with $q_p$ 2.5 m <sup>3</sup> /h	531 971
Immersion sleeve installation set R 1/2" with RL ball valves for WMZ with $q_p$ 0.6 m <sup>3</sup> /h and 1.5 m <sup>3</sup> /h	531 957
Immersion sleeve installation set R 3/4" with RL ball valves for WMZ with $q_p$ 0.6 m <sup>3</sup> /h and 1.5 m <sup>3</sup> /h	590 365
Immersion sleeve installation set R 1" with RL ball valves for WMZ with $q_p$ 0.6 m <sup>3</sup> /h and 1.5 m <sup>3</sup> /h	590 367
Immersion sleeve installation set R 3/4" with RL ball valves for WMZ with $q_p$ 2.5 m <sup>3</sup> /h	590 369
Immersion sleeve installation set R 1" with RL ball valves for WMZ with $q_p$ 2.5 m <sup>3</sup> /h	531 959

## Ordering

The part numbers shown in the type summary must be quoted in orders. If a due date other than January 1 is required, the type description must be supplemented by the required month in the order (the due date is always the first of the month).

Ordering example for a heat meter with 110 mm installation length and May 1 as due date:  
 G20/0000-00, due date: May

## Technology

The heat meter G20 / G21 comprises a pair of precise temperature sensors and a volume meter which is installed in a hot water or cooling circuit. An electronic calculator unit continually calculates the difference in temperature between the supply and return flow and multiplies the value by the flow rate. The result of this (current heating or cooling capacity) is cumulated, displayed or forwarded to a data-processing system by radio or cable. The heat meter G20 / G21 is a heat meter that can be extended by different internal and external modules. Internal modules are integrated into the device during production in the factory.

The G20 / G21 has two communication interfaces available.

1. The optical interface Q opto (1107) which is accessible from the outside. This allows programming and retrofitting work on the G20 / G21 on-site at all times. The heat meter can be retrofitted for radio or other communication means. The respective modules are simply mounted on the calculator unit.
2. The internal module interface for internal impulse output or M-Bus modules. In the case of integrated modules, the information is forwarded via a permanently mounted, threaded and sealed cable connection (impulse output and M-Bus).

## Measuring principle

The hydraulic sensor (volume meter) is based on the single-jet impeller wheel sensor principle. The scanning of impeller wheel revolutions takes place using the electrical conductance of the water in the sensor. Several electrodes are arranged in the water in such a way that an electrical signal can be discharged as the impeller wheel rotates.

## Determining water consumption

Using the measured difference in temperature between supply and return flow, the flow rate and the calculated thermal coefficient, the heat quantity is shown on the LC display in physical units (kWh, MWh, MJ, GJ) following an internal calculation process. To increase measuring accuracy, the density and enthalpy values are determined for every measurement and integrated into the calculation.

## Storing the consumption values

The heat consumption values are continually cumulated. The current status is stored at 00.00 h on the due date.

The due date can be set with the aid of a programming key; January 1 is set as the standard due date (see «Ordering» section)

When the annual consumption is stored, the heat meter calculates a plausibility figure.

This can be read out together with the due date value and checked in the billing program.

This allows incorrect display readouts (e.g. "switched digits") to be detected. The stored due date value remains in place for one year.

## Display

Device states, display units and consumption values are shown via the LC display on several levels (up to 5 levels). The heat meter is equipped with a key that can be used to switch between the individual display steps and levels. The display includes the following values:

- ~ Current heat quantity and, with G21, cold quantity
- ~ Display test
- ~ Old value heat quantity and, with G21, cold quantity
- ~ Check number heat quantity and, with G21, cold quantity
- ~ Due date
- ~ Cumulated volume
- ~ Current flow
- ~ Supply flow temperature
- ~ Return flow temperature
- ~ Temperature difference
- ~ Current energy flow
- ~ Operating hours
- ~ High-resolution heat quantity
- ~ Volume per input impulse
- ~ Software status
- ~ Any module installed
- ~ Storage date and consumption values for the last 18 months for quantity of heat and cold (with G21)

### Display level 0

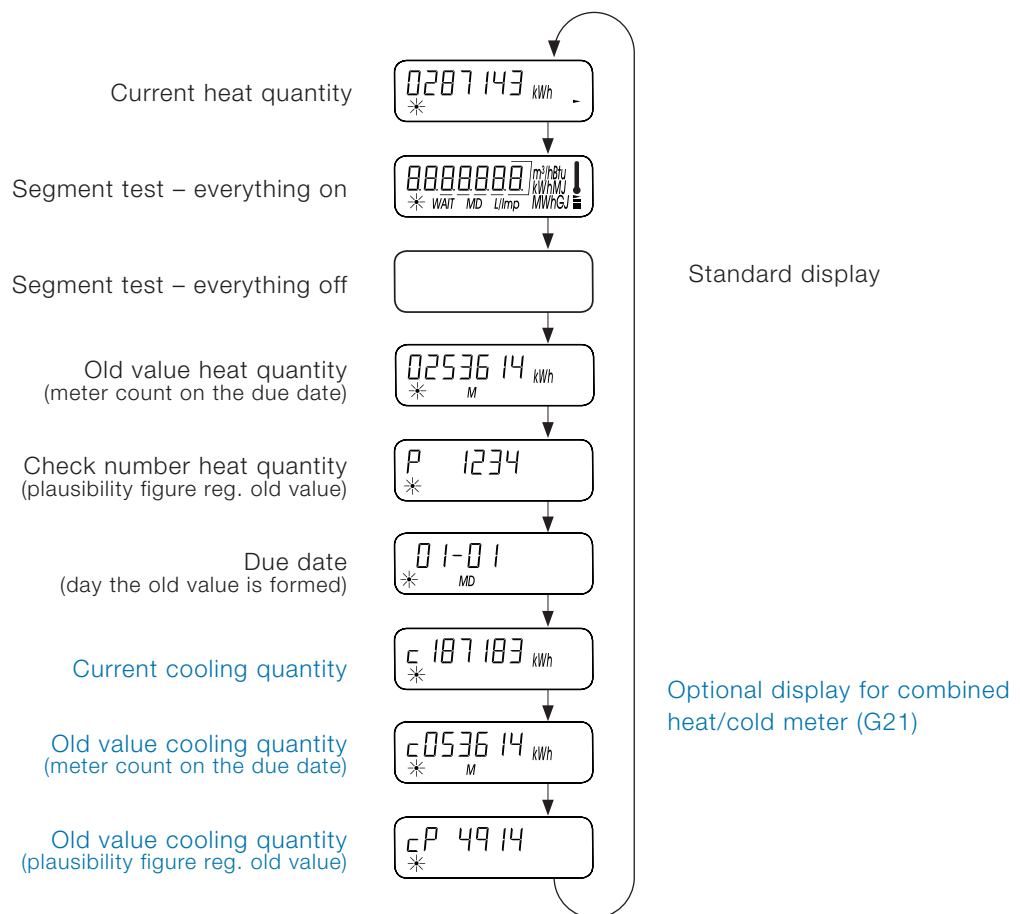

Display level 1

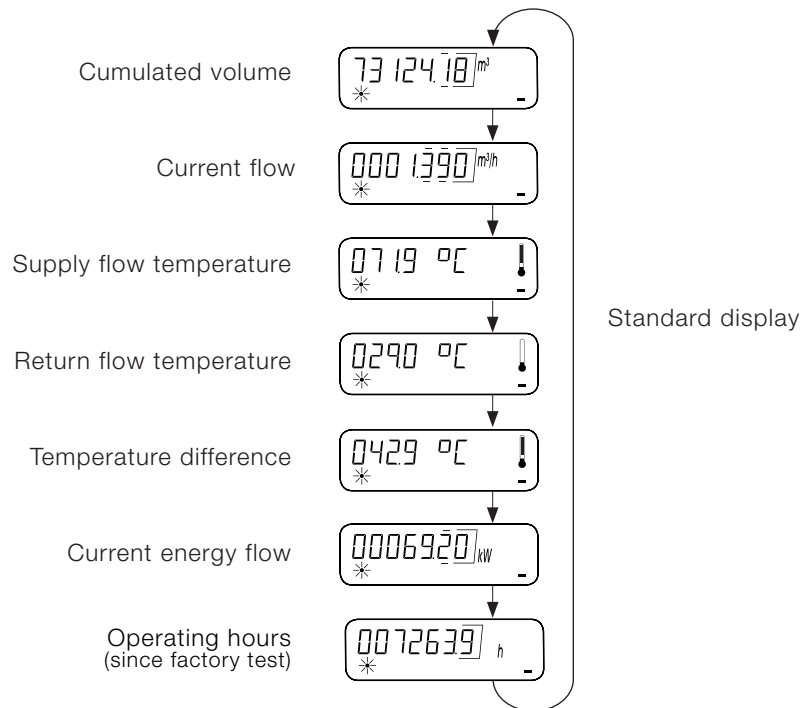

Display level 2

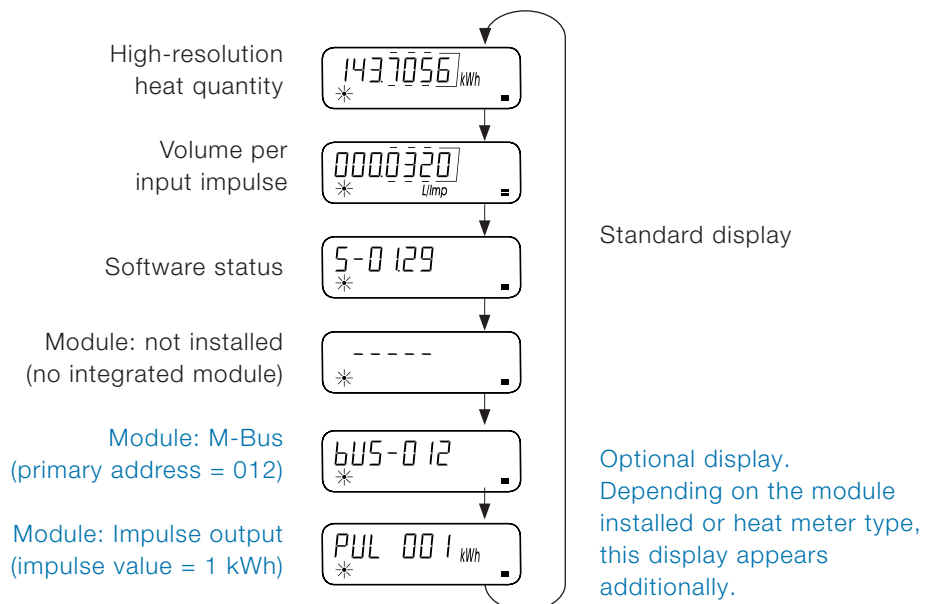



Display level 3

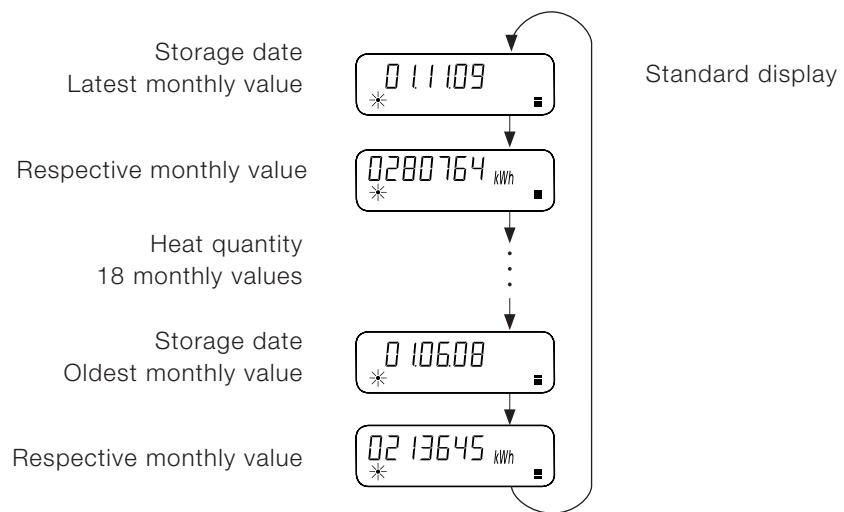

Display level 4

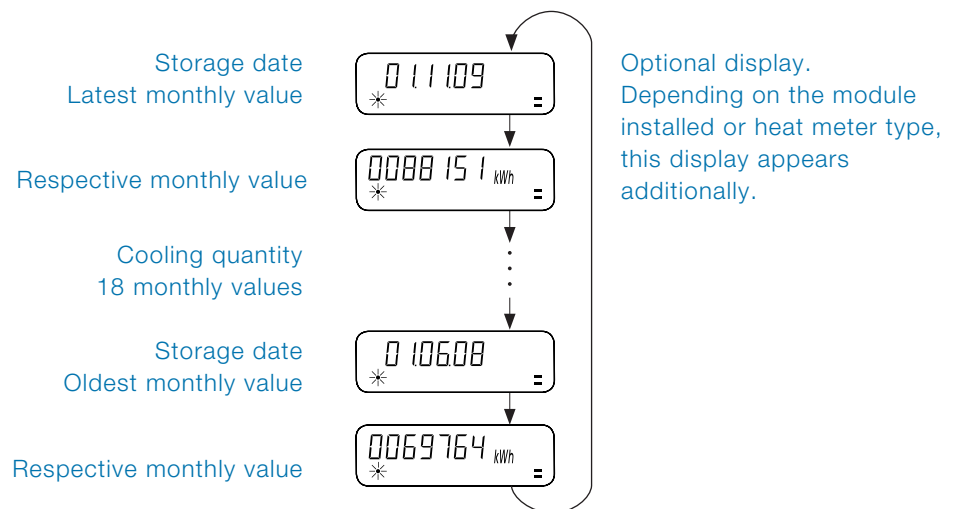

Special displays for  
error messages

The heat meter is self-monitoring and can display errors established.

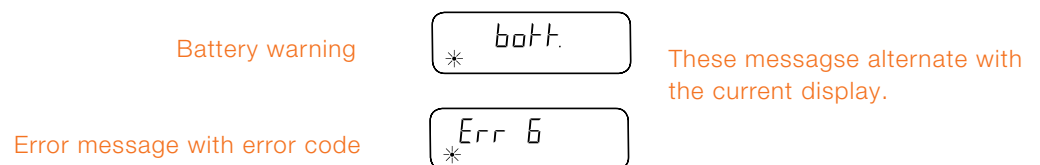

**Measurement**

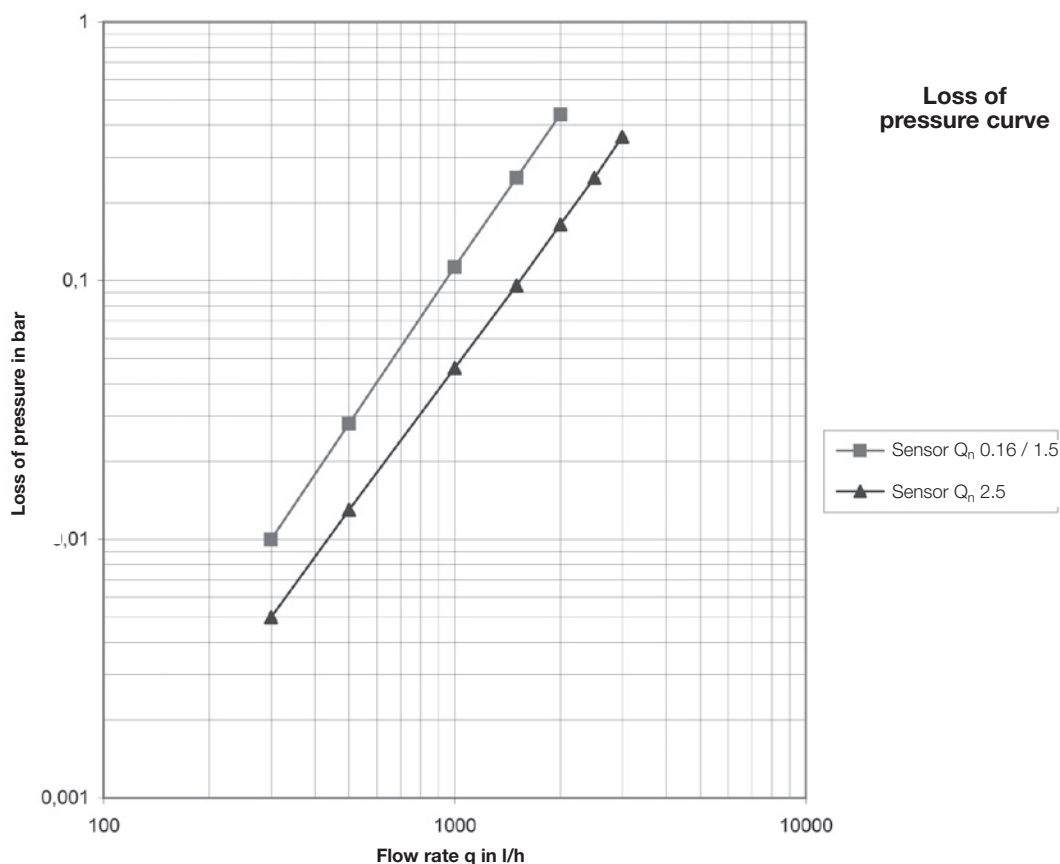

**Technical data**

Norms and standards

CE conformity	Directive 1995/5/EC (R&TTE Directive) Legislation concerning radio systems and telecommunications equipment (FTEG)
<b>Electromagnetic compatibility</b>	
Interference resistance	EN 61000-6-2
Emitted interference	EN 61000-6-3
<b>Protection rating</b>	
IP protection rating	IP54 according to EN 60529
<b>Heat meter</b>	
European Measuring Instruments Directive (MID)	2004/22/EC
Heat meter	EN1434
Quality of heat medium	VDI guideline 2035

**Technical data**

 General  
 device data

<b>Flow conditions</b>	<b>G20 / G21</b>	<b>G20 / G21</b>	<b>G20 / G21</b>
Nominal flow $Q_n$	0.6 m <sup>3</sup> /h	1.5 m <sup>3</sup> /h	2.5 m <sup>3</sup> /h
Installation position	horizontal/vertical	horizontal/vertical	horizontal/vertical
Metrological class	B (opt. C)	B (opt.C)	B (opt. C)
Start-up	3 l/h	4 l/h	5 l/h
Dynamics $Q_n/Q_{min}$	50:1 (100:1)	50:1 (100:1)	50:1 (100:1)
Minimum flow $Q_{min}$	0.012 (0.006) m <sup>3</sup> /h	0.030 (0.015) m <sup>3</sup> /h	0.050 (0.025) m <sup>3</sup> /h
Maximum flow $Q_{max}$	1.2 m <sup>3</sup> /h	3.0 m <sup>3</sup> /h	5.0 m <sup>3</sup> /h
Loss of pressure at $Q_n$	< 0.04 bar	< 0.22 bar	< 0.24 bar
Nominal pressure PN	16 bar	16 bar	16 bar
Nominal diameter	DN 15	DN 15	DN 20
<b>Connection sizes and dimensions</b>			
Installed length	110 mm	110 mm	130 mm
Connection thread on meter	G 3/4"	G 3/4"	G 1"
<b>Temperature range</b>			
Maximum temperature (for brief periods)	110 °C	110 °C	110 °C
Calibrated temperature difference	3 - 70 K	3 - 70 K	3 - 70 K
Minimum temperature difference	1.0 / 0.2 K	1.0 / 0.2 K	1.0 / 0.2 K
Type of temperature sensor	PT 1000	PT 1000	PT 1000
Cable length of temperature sensor	1.5 (opt. 3.0) m	1.5 (opt. 3.0) m	1.5 (opt. 3.0) m
<b>Energy supply</b>			
Service life	> 6 (opt. 10) years	> 6 (opt. 10) years	> 6 (opt. 10) years
Protection rating	IP 54	IP 54	IP 54
<b>Display levels</b>			
Display	7-digit LCD	7-digit LCD	7-digit LCD
Energy display	kWh (opt. MJ, GJ)	kWh (opt. MJ, GJ)	kWh (opt. MJ, GJ)

Dimensional drawing

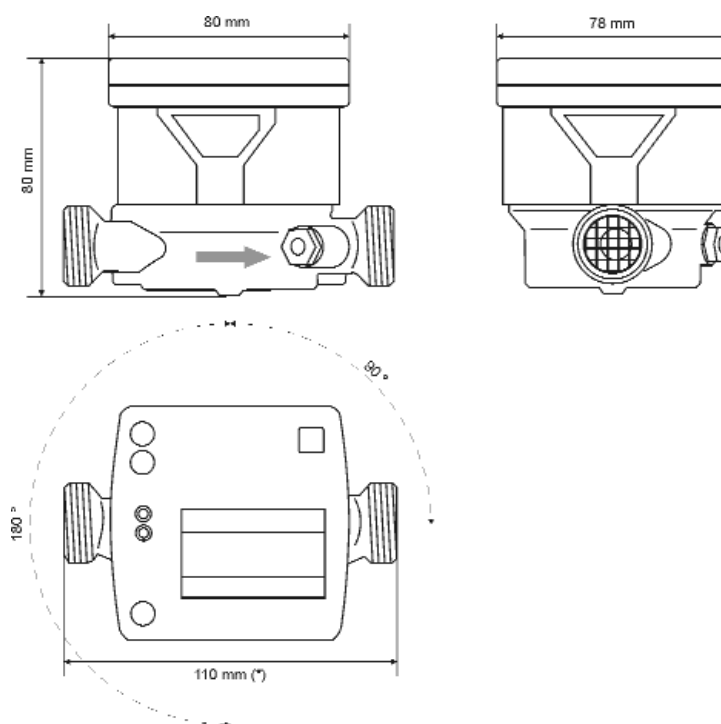

**QUNDIS GmbH**

Sondershäuser Landstraße 27  
99974 Mühlhausen / Germany  
Tel.: +49 (0) 3601 46 83-0  
Fax: +49 (0) 3601 46 83-175  
Mail: info@qundis.com

Bahnhofstraße 10  
78112 St. Georgen / Germany  
Tel.: +49 (0) 7724 93 89-0  
Fax: +49 (0) 7724 93 89-310  
Mail: info@qundis.com

The information in this data sheet only contains general descriptions or product characteristics, which may not always apply in particular application cases and/or may be subject to change through further development of the product.  
Required product characteristics are then binding if they are expressly agreed when the contract is drawn up.  
©2010 QUNDIS GmbH. Subject to change